

## Houston Series

### Features

11" diameter cast aluminum fluted base (.250 min. wall)

Choice of extruded shafts

- 4" OD smooth round (.125 wall)
- 4" OD fluted (12 flat flutes .125 wall)
- 5" OD fluted (15 flat flutes .155 wall)

Extruded shaft is circumferentially welded to the base

3" tenon for luminaire mounting

Strong yet lightweight for ease of installation

Galvanized anchor bolts included

Access door for anchor bolts and wiring is secured with tamper resistant stainless steel screws

Ground lug provided inside base

Capable of supporting multiple light brackets

### Materials

**Base** - Cast aluminum (A319)

**Shaft** - Extruded Aluminum (6005-T5)

**Tenon** - Cast aluminum (A319)

**Anchor Bolts** - Hot dipped galvanized steel

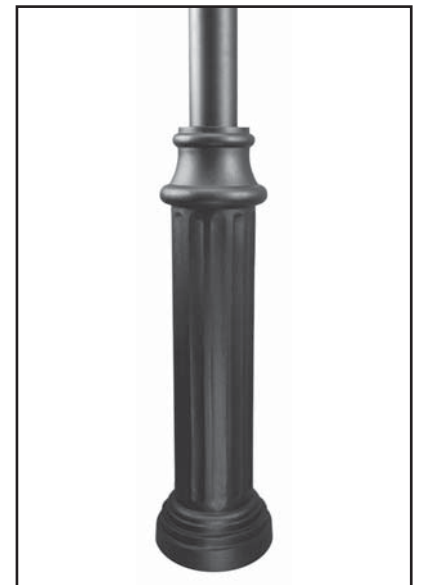

D8502-xx	D8503-xx	D8504-xx	D8505-xx	overall height
D8502-08	D8503-08	D8504-08		7'-8"
D8502-10	D8503-10	D8504-10	D8505-10	9'-8"
D8502-12	D8503-12	D8504-12	D8505-12	11'-8"
D8502-14	D8503-14	D8504-14	D8505-14	13'-8"
D8502-15	D8503-15	D8504-15	D8505-15	14'-8"
			D8505-16	15'-8"

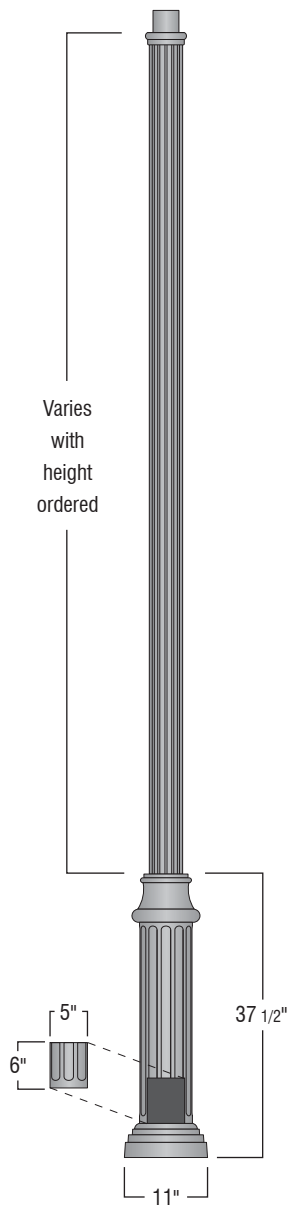

Varies with height ordered

**Finish**

The post will be finished with an electrostatically applied thermoset polyester powder coat. Prior to finishing, the parts are thoroughly cleaned using both abrasive and chemical methods. Our powder coat finish is durable, long lasting, attractive and scratch resistant as well as environmentally friendly. We offer 7 stock finishes or hundreds of special order colors including custom matching for existing projects (stock colors shown below).

Standard solid colors are:

- GRN** - Green
- CLB** - Classic Bronze
- TBK** - Textured Black
- BLK** - Satin Black

Premium finishes are:

- GTG** - Granite Green
- ATC** - Antique Copper
- WHT** - White

**Accessories** See "Accessories" section for more information

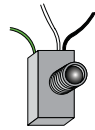

**PCL**  
Dusk to dawn photocell Available for 120v (PCL) or 208-277v (PCL multi).



**Banner Arms**  
Field rotatable or fixed location banner arms.

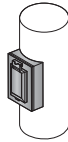

**GFCI**  
Ground fault circuit protected duplex outlet. Available Recess mounted (GFCI-RM) as shown or surface mount (GFCI-SM).



**Street Signage**  
Several mounting options and custom signs available. See guide in accessories section.

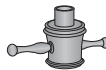

**LR**  
Cast aluminum decorative ladder rest. Slip fits 3" o.d. pole or tenon (not designed to support ladder).

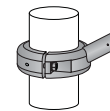

**FPH-4 or FPH-5**  
Extruded aluminum holder for 1" OD flag poles. Available for 4" OD and 5" OD non-tapered pole.

**Accessory Orientation Guide**

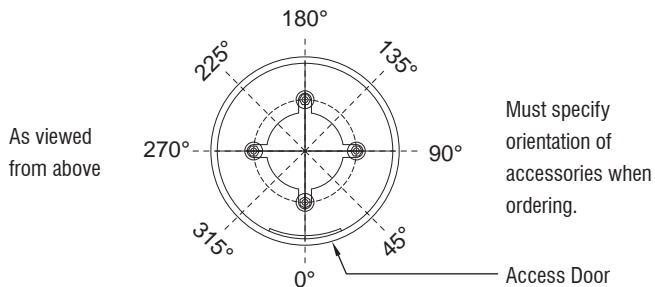

**Anchor Details**

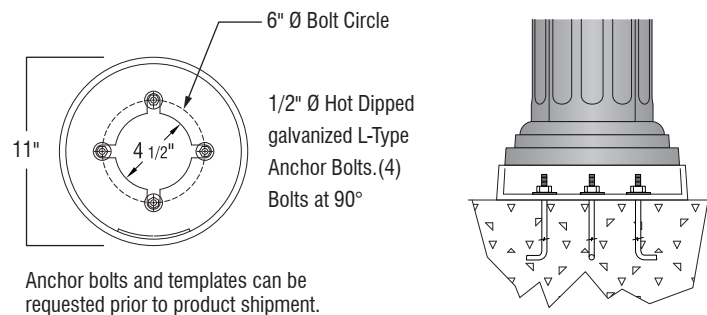

**Ordering Guide**

