

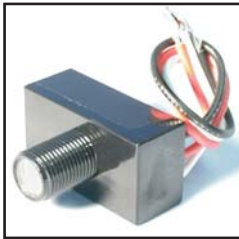

GCO

Single grounded convenience outlet. (not GFCI protected -check local codes for suitability) Weatherproof with cover closed only. Installed in pole shaft. See Accessory orientation guide to specify location.



PCL (120v only)

PCL-MULTI (208v thru 277v)

Dusk to dawn button type photocell for automatic switching of luminaires. Black polycarbonate housing. See Accessory orientation guide to specify location.

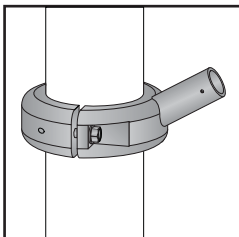

FPH-4 or FPH-5

Extruded aluminum holder for 1" OD flag poles. The flag pole holder is set at 45° angle and welded to a field rotatable and height adjustable collar. Available for 4" OD and 5" OD non-tapered pole.

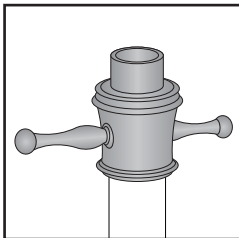

LR

Cast aluminum decorative ladder rest slip fits 3" OD pole or tenon. Integral 3" OD cast tenon provided for luminaire mounting (not designed to support ladder or other objects).

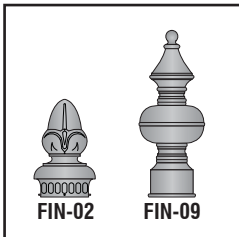

Pole Finials

Decorative post top finials for use with side mount brackets or when signs are installed without luminaires. Finials attach to 3" OD pole or tenon with 3 set screws.

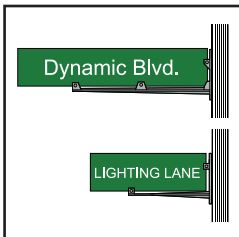

Street Signs

Street name signs, informational and directional signs along with mounting systems are available to complete any street scape. See "STREET SIGNS" page for details.

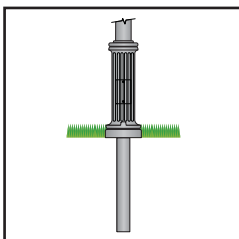

Direct Burial Option

Direct burial extensions are available for most Cast / Extruded poles. Contact factory for details.

Banner Arms

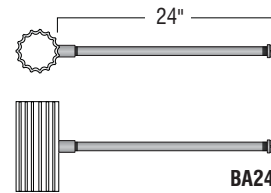

Fixed position banner arm for 4" or 5" OD poles (can be used on tapered poles). Aluminum 3/4" NPT coupling is permanently welded at the specified location. 24" extruded aluminum banner arm is removable.

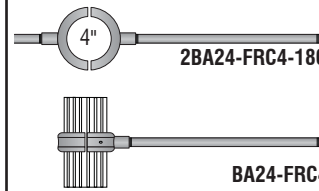

Single or double field rotatable arms for 4" OD non-tapered poles. 3/4 NPT x 24" long extruded aluminum arm threads onto cast collar that clamps to pole with (2) 3/8" dia. stainless steel socket head screws. Other lengths available.

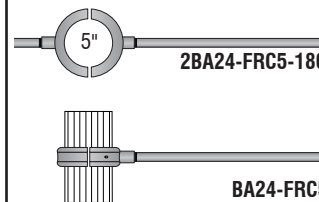

Single or double field rotatable arms for 5" OD non-tapered poles. 3/4 NPT x 24" long extruded aluminum arm threads onto cast collar that clamps to pole with (2) 3/8" dia. stainless steel socket head screws. Other lengths available.

Finish on all arms will match posts

GFCI

The 20 amp, 125 volt, ground fault circuit interrupter duplex receptacles are recessed (**RM**) or surface mounted (**SM**) to the post or base. The receptacles shall have a cast aluminum UL listed cover. The **GFCI-WWIU** has a cover that is suitable for wet locations while in use. The receptacle and cover shall mount to an outlet opening, in the post shaft or base, with a gasket and stainless steel screws. Finish will match pole.

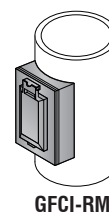

GFCI-RM

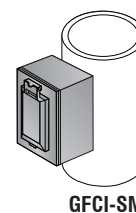

GFCI-SM

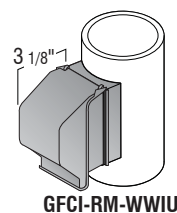

GFCI-RM-WWIU

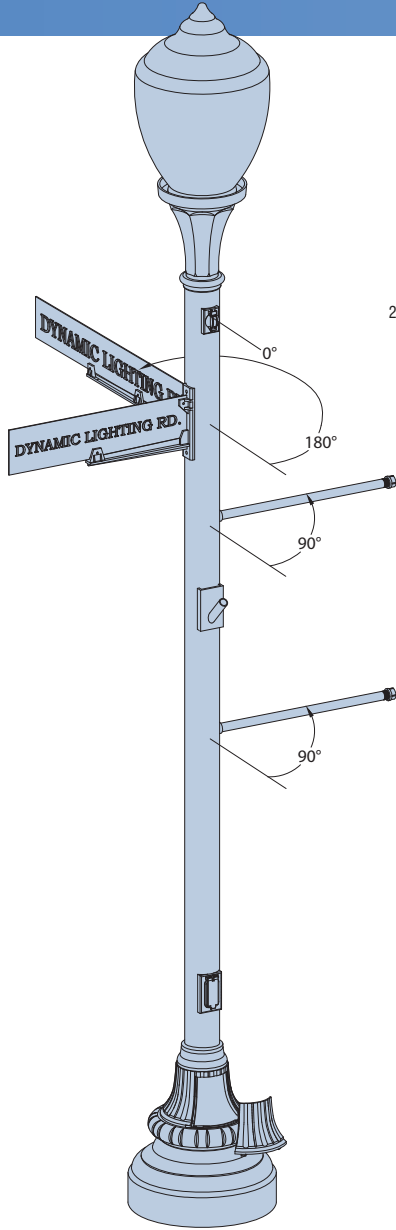

D1010S, D1012S

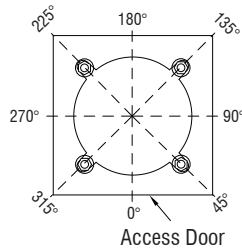

D1010-S14 D1012-S14

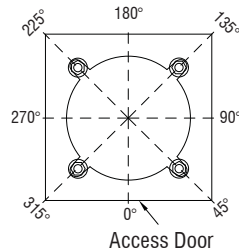

D1012R

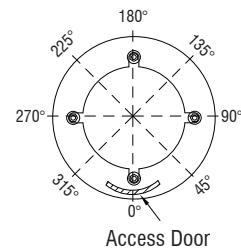

D1103

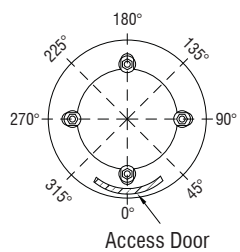

D1300 Series

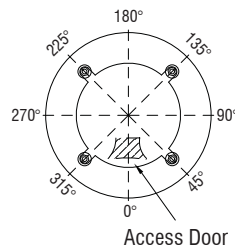

**D1405, D1010
D1012 Series**

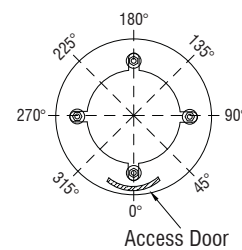

D1900 Series

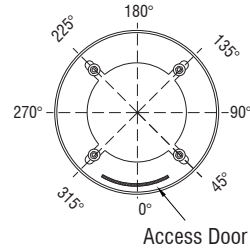

**D20 Series,
D2011, D2013**

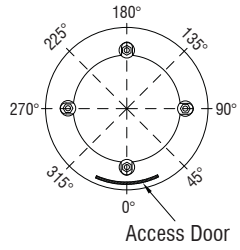

D30 Series

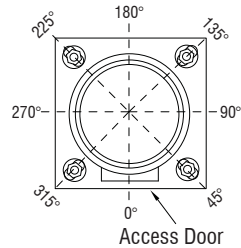

D35 Series

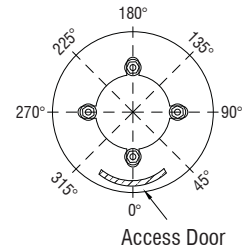

D4030 Series

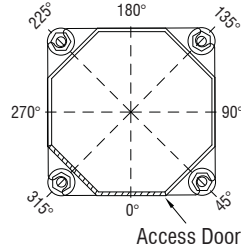

D40 & D4070 Series

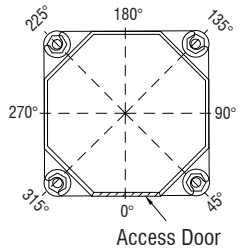

D45 Series

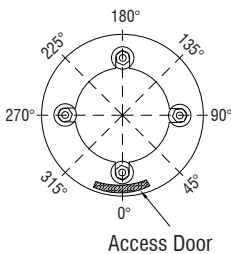

D50 Series

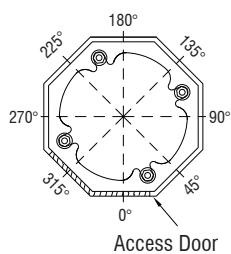

D55 Series

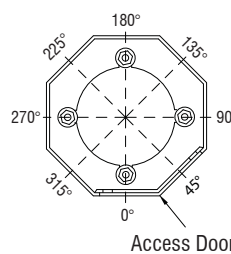

D67

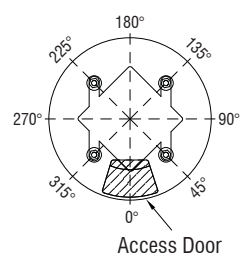

D75 Series

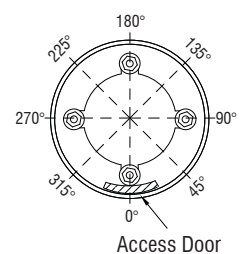

D85 Series

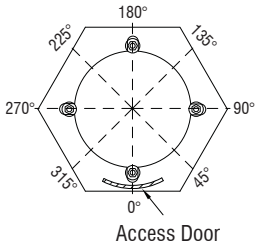

D90 Series

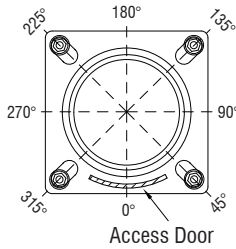

DVH1800 Series

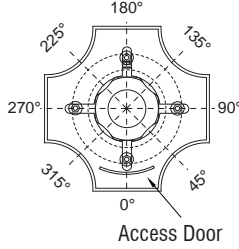

D2600 Series

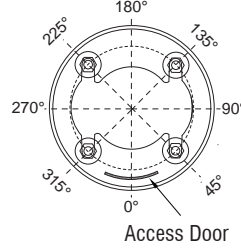

D7500 Series

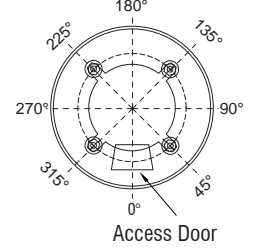

D8500 Series

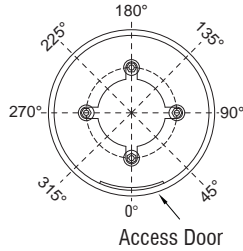

D9000 Series

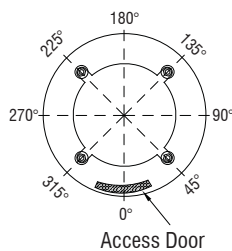

DFS9100 Series

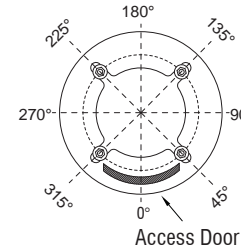

D9200 Series

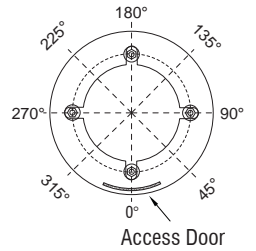

DSD17 Series

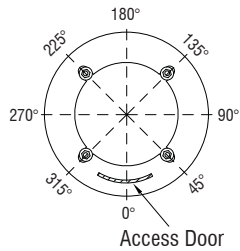

DU4100 Series

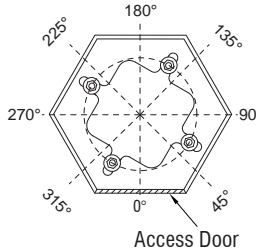

DSD20

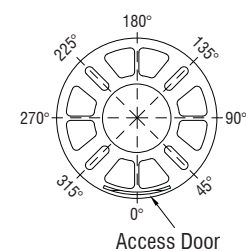

EA6 Series

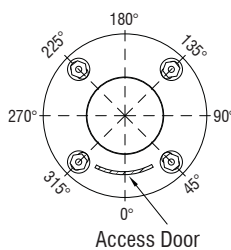

DP04/PLT, FP04/PLT, TP043/PLT

