

Verona Series

Features

18" diameter fluted and tapered fluted cast aluminum base (.250 min. wall)

Choice of extruded shafts

- 4" OD smooth round
- 4" OD fluted (12 flat flutes)
- 5" OD fluted (15 flat flutes)

Extruded shaft is circumferentially welded to the base

3" tenon for luminaire mounting

Strong yet lightweight for ease of installation

Galvanized anchor bolts included

Access door for anchor bolts and wiring is secured with tamper resistant stainless steel screws

Ground lug provided inside base

Capable of supporting multiple light brackets

Materials

Base - Cast aluminum (A319)

Shaft - Extruded Aluminum (6005-T5)

Tenon - Cast aluminum (A319)

Anchor Bolts - Hot dipped galvanized steel

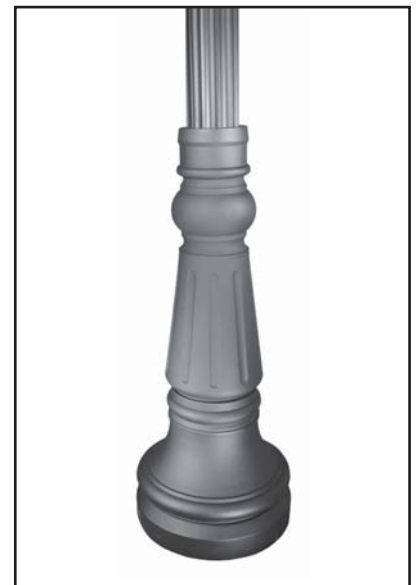

D9003-xx	D9004-xx	D9005-xx	over all height
D9003-08	D9004-08		7'-7"
D9003-10	D9004-10	D9005-10	9'-7"
D9003-12	D9004-12	D9005-12	11'-7"
D9003-14	D9004-14	D9005-14	13'-7"
D9003-15	D9004-15	D9005-15	14'-7"
		D9005-16	15'-7"

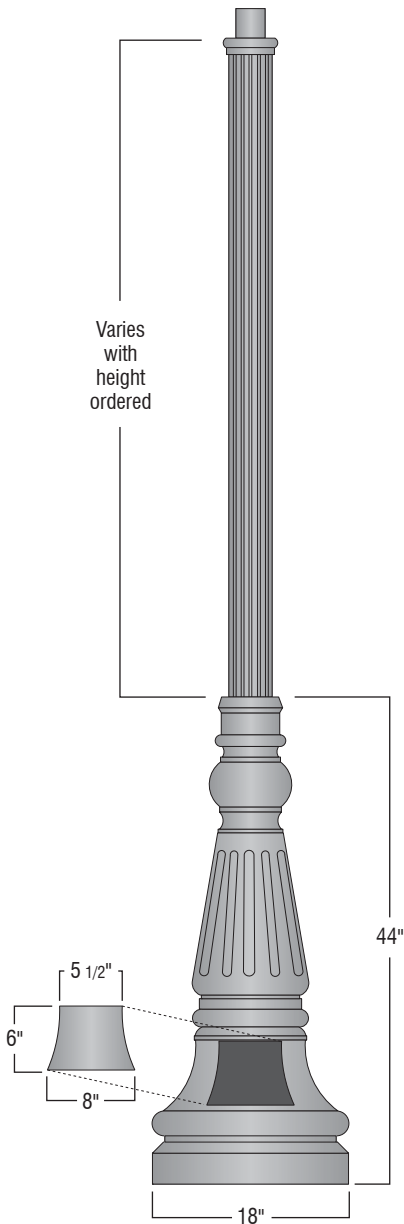

Finish

The post will be finished with an electrostatically applied thermoset polyester powder coat. Prior to finishing, the parts are thoroughly cleaned using both abrasive and chemical methods. Our powder coat finish is durable, long lasting, attractive and scratch resistant as well as environmentally friendly. We offer 7 stock finishes or hundreds of special order colors including custom matching for existing projects (stock colors shown below).

Standard solid colors are:

- GRN** - Green
- CLB** - Classic Bronze
- TBK** - Textured Black
- BLK** - Satin Black

Premium finishes are:

- GTG** - Granite Green
- ATC** - Antique Copper
- WHT** - White

Accessories See "Accessories" section for more information

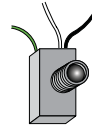

PCL
Dusk to dawn photocell
Available for 120v (PCL)
or 208-277v (PCL multi).



Banner Arms
Field rotatable
or fixed location
banner arms.

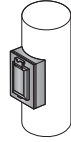

GFCI
Ground fault circuit
protected duplex outlet.
Available Recess
mounted (GFCI-RM) as
shown or surface mount
(GFCI-SM).



Street Signage
Several mounting
options and custom
signs available. See
guide in accessories
section.

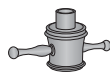

LR
Cast aluminum decorative
ladder rest. Slip fits 3"o.d.
pole or tenon (not
designed to support
ladder).

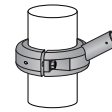

FPH-4 or FPH-5
Extruded aluminum
holder for 1" OD flag
poles. Available for 4"
OD and 5" OD
non-tapered pole.

Accessory Orientation Guide

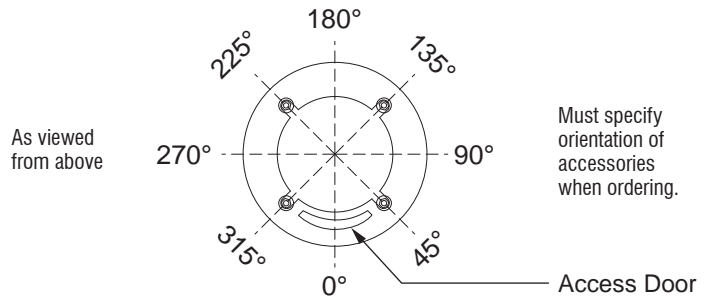

Anchor Details

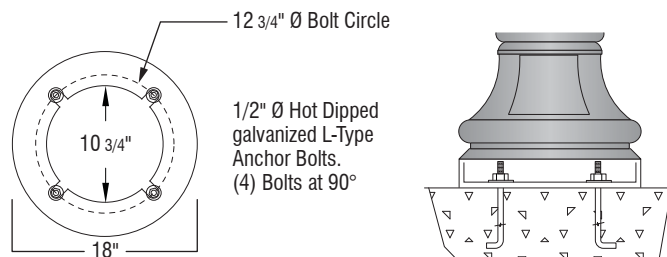

Anchor bolts and templates can be requested prior to product shipment.

Ordering Guide

